

robot *coupe*®



IMMERSION BLENDERS



RESTAURANTS - CATERERS - DELICATESSENS

COMPACTE

"All Robot Coupe Immersion Blenders have One Year "No Hassle" Replacement Warranty**"

MINI

Mini MP

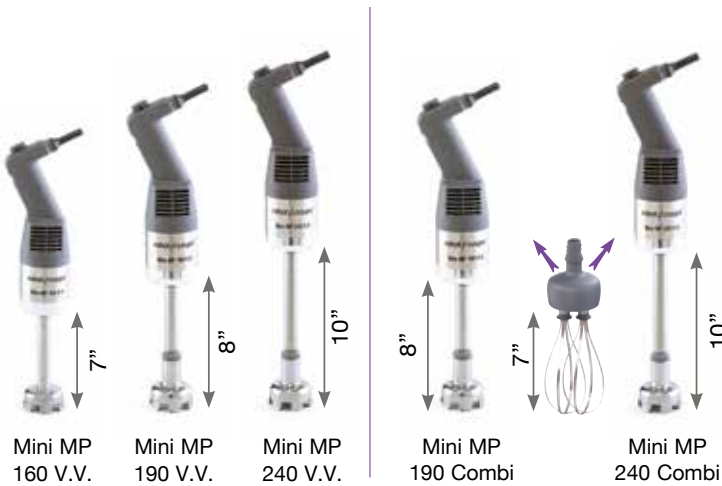

Ideal for smaller quantities

CMP

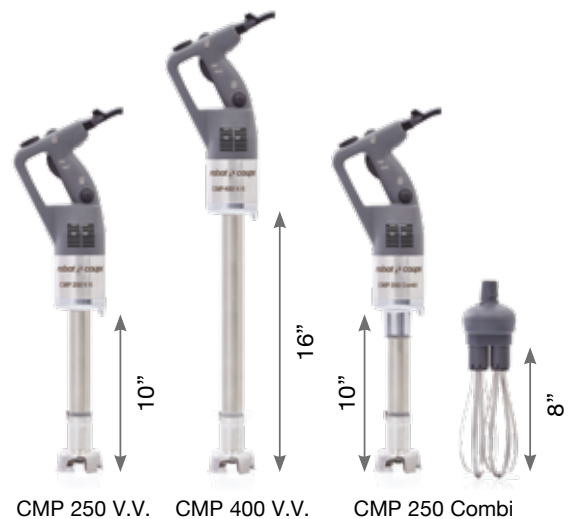

CMP 250 V.V. CMP 400 V.V. CMP 250 Combi

15 L

73 L

15 L

Restaurants

▶ For handling small quantities

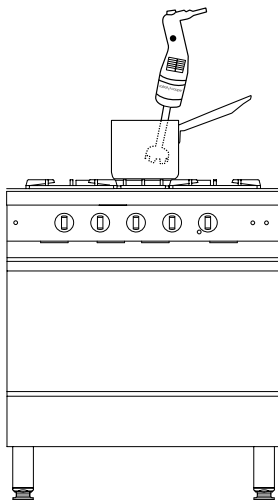

Mini MP

▶ Special for restaurants Up to 73 Liters

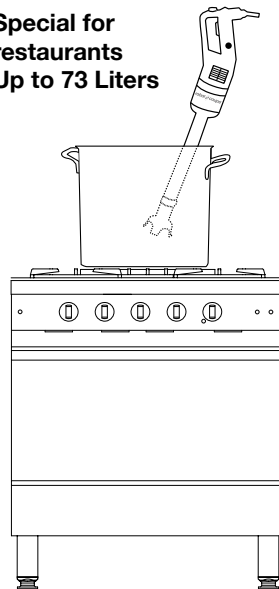

CMP

▶ Intended for institutional and commercial caterers. Intensive use.

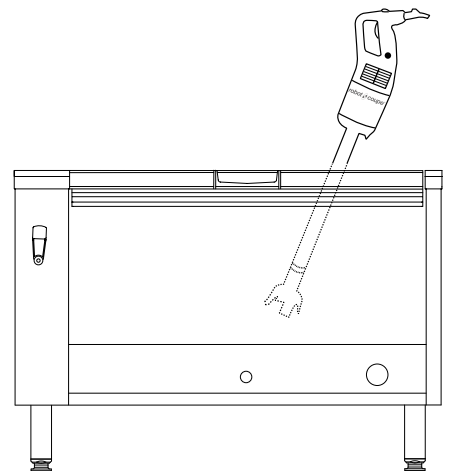

MP Ultra

LARGE

MP

MP 350	MP 450	MP 550	MP 600	MP 800	MP 350 Combi	MP 450 Combi	MP 450 FW	MP 450 XL FW
14"	18"	21"	24"	29"	14"	18"	10"	27"
50 L	100 L	200 L	300 L	400 L	50 L	100 L	100 L	100 L

Large production and institutions



▶ MINI RANGE



▶ Mixer



▶ Emulsify



▶ Beat

FOR HANDLING SMALLER QUANTITIES

COMBI

<p>240 W</p>  <p>7 inches</p> <p>Mini MP 160 V.V.</p>	<p>270 W</p>  <p>8 inches</p> <p>Mini MP 190 V.V.</p>	<p>290 W</p>  <p>10 inches</p> <p>Mini MP 240 V.V.</p>
---	---	--

2,000 to
12,500 rpm

<p>270 W</p>  <p>7 inches</p> <p>Mini MP 190 Combi</p>	<p>290 W</p>  <p>7 inches</p> <p>Mini MP 240 Combi</p>
--	--

Mixer: 2,000 to 12,500 rpm
Whisk: 350 to 1,560 rpm

▶ MINI RANGE

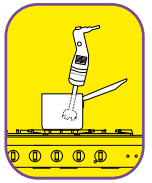

Minimum size, maximum performance!
For sauces, emulsions and small preparations.

VARIABLE SPEED

- 2,000 to 12,500 rpm in mixer function
- 350 to 1,560 rpm in whisk function

ERGONOMICS

Shape of the handle specifically designed to ensure a good grip and manipulation of the Immersion Blender, thus reducing user fatigue.

POWERFUL

A powerful motor (240-290 W according to model) for an even longer lifespan!



STAINLESS
STEEL
BELL



SANITATION

Detachable tube and blade assembly for perfect sanitation, with a patented system exclusive to Robot-Coupe. Tube, bell and blade assembly all made from stainless steel for a longer lifespan.

The Mini MP 190 V.V. and Mini MP 240 V.V. models have a detachable bell.

MULTIPURPOSE



Overmoulded stainless-steel blades ensuring perfect sanitation and ideal for making coulis, cream soups and sauces.



Detachable stainless-steel emulsifying disc for aerating hot and cold sauces and giving them a foamy consistency.

▶ COMPACT RANGE CMP

NEW

▶ Mixer



▶ Beat



SPECIALLY DESIGNED FOR THE CATERING SECTOR

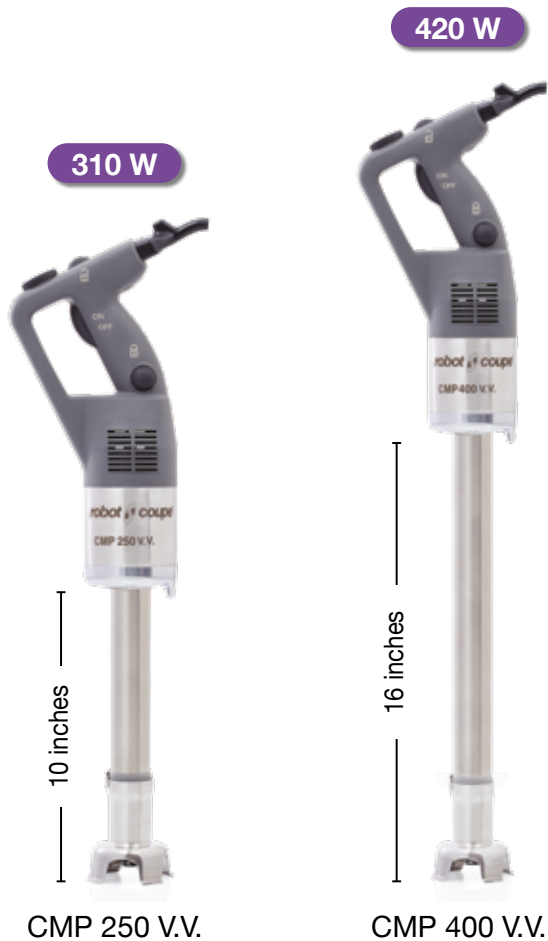

5,000 to 10,000 rpm



Mixer: 2,300 to 10,000 rpm
Whisk: 500 to 1,800 rpm

▶ COMPACT RANGE CMP

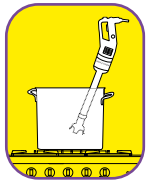

Compact, easy-to-handle, high-performance.
For restaurants & cafés

ERGONOMICS

Light, compact, easy-to-handle appliance.

POWERFUL

High-strength motor:
+15 % for greater efficiency.



SANITATION

Removable stainless steel blade and bell for easy cleaning and maintenance.

MULTIPURPOSE



The CMP Combi models (mixer+whisk) also boast a new 100% stainless-steel bell



Optimum blending quality giving the finished product a fine texture in minimal time.



COMFORT

Variable speed function providing the greater flexibility required for **sophisticated preparations.**

ERGONOMICS

New cord winder to make it easier to store and prevent wear and tear.

STAINLESS
STEEL
BELL

AFTER SALES SERVICE: DETACHABLE POWER CORD

- 1 The new patented "EasyPlug" system** means that the power cord can be easily replaced during after-sales servicing.
- 2 The indicator lights** up when machine starts functioning and the cable is not damaged and correctly plugged in on both sides (wall socket and EasyPlug).



▶ LARGE RANGE

▶ Mixer



▶ Beat

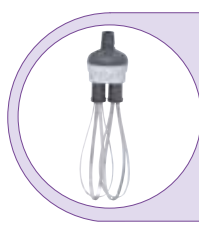

SPECIALLY DESIGNED / COMMERCIAL CATERING

NEW

660 W

14 inches

MP 350

720 W

18 inches

MP 450

840 W

21 inches

MP 550

920 W

24 inches

MP 600

1000 W

29 inches

MP 800 Turbo

MP 350/MP 450: 12,000 rpm			
MP 350 V.V. / MP 450 V.V.: 3,000 to 10,000 rpm	12,000 rpm	12,000 rpm	12,000 rpm

COMBI

660 W

14 inches

MP 350 Combi

10 inches

720 W

18 inches

MP 450 Combi

720 W

MP 450 FW

Mixer: 3,000 to 10,000 rpm	
Whisk: 500 to 1,500 rpm	250 to 1,500 rpm

▶ LARGE RANGE

MP LARGE PRODUCT RANGE

Even better performance and ergonomics!

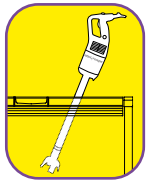

ERGONOMICS

Ergonomic handle for greater convenience.



For the MP V.V. and MP Combi models, **more ergonomic variable speed button** for greater convenience.

PERFORMANCE

High-Power motor: **+20%** for greater efficiency.
Increased performance to **optimise blending time.**

LONG SERVICE LIFE

Stainless steel motor base for intensive use.

ERGONOMICS

New cord winder to make it easier to store and prevent wear and tear.

INNOVATION



SANITATION

Removable stainless steel bell and blade for easy cleaning and maintenance.

NEW

New EasyGrip removable handle.

The machine's weight is distributed better making it even easier to use!



AFTER SALES SERVICE: DETACHABLE POWER CORD

- 1 The new patented "EasyPlug" system means that the power cord can be easily replaced during after-sales servicing.
- 2 The indicator lights up when machine starts functioning and the cable is not damaged and correctly plugged in on both sides (wall socket and EasyPlug).



▶ COMBI PRODUCT RANGE

The Robot-Coupe whisk attachment available for Mini MP Combi, CMP Combi, MP Combi and MP FW mixers is designed to emulsify, mix, shell, beat and knead.

POWERFUL

High-strength motor: +15 % for greater efficiency.

EASY TO OPERATE

Variable speed button easy to use with one hand.

ERGONOMIC

Ergonomic handle for easier grasping.

CONVENIENT

Self regulating speed system for sophisticated preparations.



METAL WHISK BOX



HEAVY DUTY

Metal gears inside 2 metal housings to stand up to heavy duty use.

SANITATION

Overmoulded whisks to ensure perfect sanitation.

ERGONOMIC

Fast coupling of whisks to the gearbox and the gearbox to the motor housing for easy assembly and disassembly.



MIXING TOOL ATTACHMENT

Ergonomic handle

Rubber protection

- **Variable speed** from 150 to 510 rpm
- Total length of the tool : **690 mm**
- **Available as an optional extra with the Combi models.**

Uses:

potato flakes, dehydrated base for soups etc...

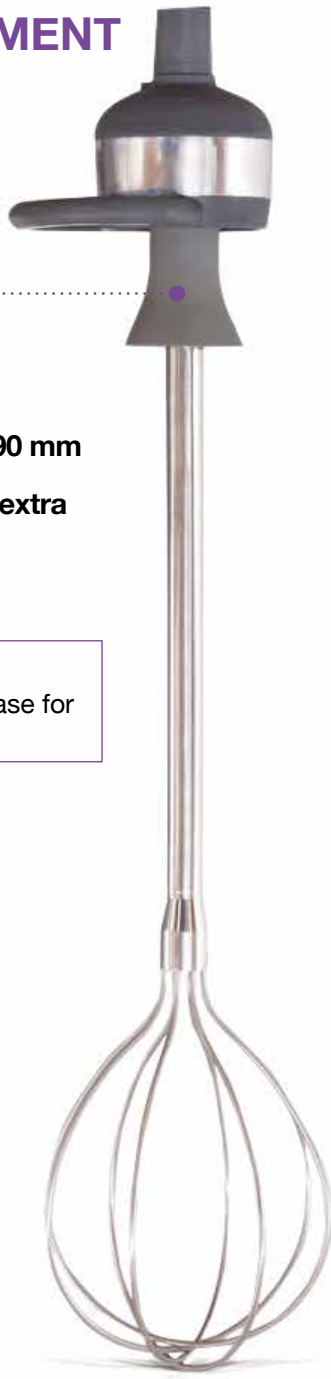

FOOD SANITATION ADVICE CLEANING

Bell and blade removable for ease of cleaning



1

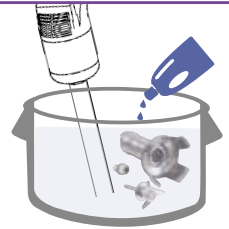

≥5 min

2

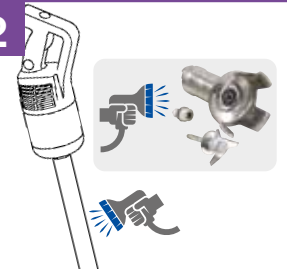

3

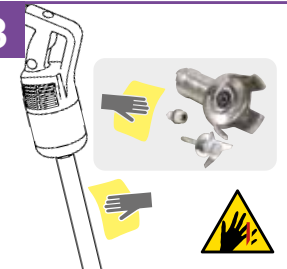

4

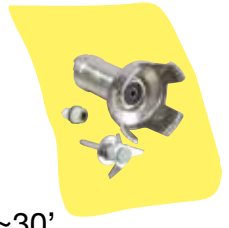

~30'



In line with HACCP advice, the cleaned bell and blade should be stored in a cold room after use

EXCLUSIVE TECHNOLOGY

The main benefits

- **Perfect sanitation:** Foot, knife, bell, and whisk fully removable - a Robot-Coupe exclusive.
- **Robust machine:** The design of the machines and the materials used in their construction guarantee a sturdy machine.
- **Large processing capacity:** Powerful motor for fast processing and an optimum quality end-product.
- **Easy maintenance:** All stainless steel tube, bell, knife and whisk.
- **Compact models:** Space saving and easy to use. 5 models to process small quantities.



Pan capacity

Between 2 and 400 litres according to the model.



Targets

Restaurants, Caterers, Delicatessens, Day Nurseries.



In Brief

The performance in terms of sanitation, ease of use, multiple functions, longer life, and profitability make it the best choice on the market.

MINI RANGE	Electrical data			Dimensions (in inches)				Weight (lb)	
	Variable speed (rpm)	Power (Watts)	Voltage* (Amp.)	A	B	C	D	Net	Gross
Mini MP 160 V.V.	2,000 to 12,500	240	120V/60/1	3	18 ½	3	7	3.1	5
Mini MP 190 V.V.	2,000 to 12,500	270	120V/60/1	3	20 ½	3	8	3.2	5
Mini MP 240 V.V.	2,000 to 12,500	290	120V/60/1	3	20 ½	3	12	3.3	5

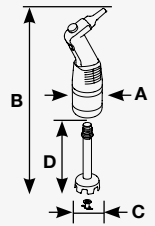

COMPACT RANGE	Electrical data			Dimensions (in inches)				Weight (lb)	
	Variable speed (rpm)	Power (Watts)	Voltage* (Amp.)	A	B	C	D	Net	Gross
CMP 250 V.V.	5,000 to 10,000	310	120V/60/1	3.7	26	3.5	10	6.6	10
CMP 400 V.V.	5,000 to 10,000	420	120V/60/1	3.7	30	3.5	16	7.2	11

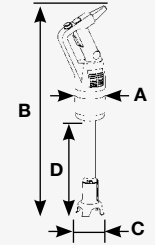

LARGE RANGE	Electrical data				Dimensions (in inches)						Weight (lb)	
	Speed (rpm)		Power (Watts)	Voltage* (Amp.)	A	B	C	D	E	F	Net	Gross
	Mixer	Mixer Variable speed										
MP 350	12,000	-	660	120V/60/1	5	30.5	3.9	14			10.1	15
MP 350 V.V.	-	3,000 to 10,000	660	120V/60/1	5	30.5	3.9	10	17	4	10.5	15
MP 450	12,000	-	720	120V/60/1	5	32.5	3.9	18			10.7	15
MP 450 V.V.	-	3,000 to 10,000	720	120V/60/1	5	32.5	3.9	10	17	4	11	15
MP 550	12,000	-	840	120V/60/1	5	36.5	4.4	21			11.4	16
MP 600	12,000	-	920	120V/60/1	5	38	4.3	23			12.5	17
MP 800	12,000	-	1,000	120V/60/1	5	44.5	4.3	29			15.6	21

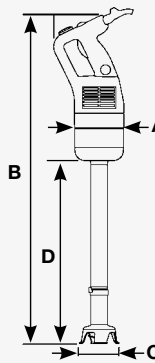

COMBI RANGE	Electrical data				Dimensions (in inches)						Weight (lb)	
	Mixer Variable speed (rpm)	Whisk Variable speed (rpm)	Power (Watts)	Voltage* (Amp.)	A	B	C	D	E	F	Net	Gross
Mini MP 190 Combi	2,000 to 12,500	350 to 1,560	270	120V/60/1	3	20 ½	3	8	10	3.9	4.3	7
Mini MP 240 Combi	2,000 to 12,500	350 to 1,560	290	120V/60/1	3	20 ½	3	12	10	3.9	4.4	7
CMP 250 Combi	2,300 to 10,000	500 to 1,800	310	120V/60/1	3.7	24	3.5	10	15.4	4.7	6.6	13
MP 350 Combi	3,000 to 10,000	500 to 1,500	660	120V/60/1	4.9	30.5	3.9	14	17.3	4.7	13	18
MP 450 Combi	3,000 to 10,000	500 to 1,500	720	120V/60/1	4.9	34.5	3.9	18	17.3	4.7	13.4	19
MP 450 FW	-	250 to 1,500	720	120V/60/1	5	31.7	-	-	17.3	4.7	9.4	15
MP 450 XL FW	-	150 to 510	720	120V/60/1	6	46.3	-	-	32	6.9	11	20

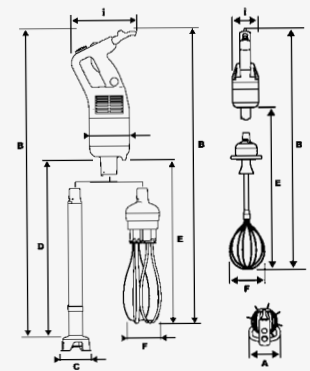

*Other voltages available.



Robot Coupe® U.S.A., Inc.

264 South Perkins - Ridgeland, MS 39157

Phone : 800/824-1646 • 601/898-8411

email : info@robotcoupeusa.com

www.robot-coupe.com

DISTRIBUTOR

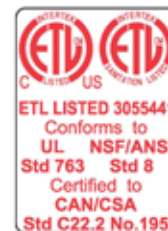

We reserve the right to alter at any time without notice the technical specifications of this appliance. None of the information contained in this document is of a contractual nature. Modifications may be made at any time.

© All rights reserved for all countries by: ROBOT COUCPE S.N.C.